

# W 38 × H 42 mm Analog Timers



## ATS Series PRODUCT MANUAL

For your safety, read and follow the considerations written in the instruction manual, other manuals and Autonics website.

The specifications, dimensions, etc. are subject to change without notice for product improvement. Some models may be discontinued without notice.

### Features

- Wide power supply range  
: 100 - 240 VAC ~ 50 / 60 Hz, 24 - 240 VDC = / 24 VAC ~ 50 / 60 Hz, 24 VDC = / 12 VDC =
- Various output operations (6 operation modes)
- Multi time range (12 types of time range)
- Wide time setting range (0.1 sec to 30 hour)
- Close and DIN rail mounting with the dedicated socket (PS-M8) width 41 mm (ATS8)
- Easy mounting and installation / maintenance with the dedicated bracket for DIN 48 × 48 mm

### Safety Considerations

- Observe all 'Safety Considerations' for safe and proper operation to avoid hazards.
- ⚠ symbol indicates caution due to special circumstances in which hazards may occur.

**⚠ Warning** Failure to follow instructions may result in serious injury or death.

- 01. Fail-safe device must be installed when using the unit with machinery that may cause serious injury or substantial economic loss. (e.g. nuclear power control, medical equipment, ships, vehicles, railways, aircraft, combustion apparatus, safety equipment, crime/disaster prevention devices, etc.)**  
Failure to follow this instruction may result in personal injury, economic loss or fire.
- 02. Do not use the unit in the place where flammable/explosive/corrosive gas, high humidity, direct sunlight, radiant heat, vibration, impact or salinity may be present.**  
Failure to follow this instruction may result in explosion or fire.
- 03. Install on a device panel to use.**  
Failure to follow this instruction may result in fire or electric shock.
- 04. Do not connect, repair, or inspect the unit while connected to a power source.**  
Failure to follow this instruction may result in fire or electric shock.
- 05. Check 'Connections' before wiring.**  
Failure to follow this instruction may result in fire.
- 06. Do not disassemble or modify the unit.**  
Failure to follow this instruction may result in fire or electric shock.

**⚠ Caution** Failure to follow instructions may result in injury or product damage.

- 01. Use the unit within the rated specifications.**  
Failure to follow this instruction may result in fire or product damage.
- 02. Use a dry cloth to clean the unit, and do not use water or organic solvent.**  
Failure to follow this instruction may result in fire or electric shock.
- 03. Keep the product away from metal chip, dust, and wire residue which flow into the unit.**  
Failure to follow this instruction may result in fire or product damage.

### Cautions during Use

- Follow instructions in 'Cautions during Use'. Otherwise, it may cause unexpected accidents.
- In case of DC power input, connect it to the designated power input terminals considering the polarity.
- Power supply should be insulated and limited voltage/current or Class2, SELV power supply device.
- When applying the power to the timer, apply the rated power at the moment by switch and relay, etc. Otherwise, it may cause malfunction.
- When supplying or turning off the power, use a switch or etc. to avoid chattering.
- Install a power switch or circuit breaker in the easily accessible place for supplying or disconnecting the power.
- In order to block peripheral current, use isolation transformer which of secondary part is not grounded to supply power to the external input device.

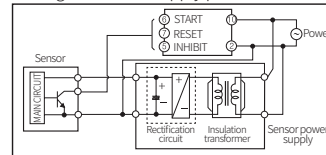

- In order to avoid leakage current flowing, connect resistance and condenser like below. Otherwise, it may cause malfunction.

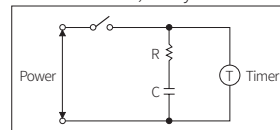

- Do not connect two or more timers with only one input contact or transistor simultaneously.
- After turning off the power, change the time range, etc.
- Keep away from high voltage lines or power lines to prevent inductive noise. In case installing power line and input signal line closely, use line filter or varistor at power line and shielded wire at input signal line.
- Do not use near the equipment which generates strong magnetic force or high frequency noise.
- This unit may be used in the following environments.
  - Indoors (in the environment condition rated in 'Specifications')
  - Altitude max. 2,000 m
  - Pollution degree 2
  - Installation category II

## Ordering Information

This is only for reference, the actual product does not support all combinations. For selecting the specified model, follow the Autonics website.

**ATS** ① - ② ③ ④

### ① Plug type

- 8: 8-pin plug
- 11: 11-pin plug

### ③ Time range

- 1: 0.1 to 1
- 3: 0.3 to 3

### ② Power supply

- 1: 12 VDC≒
- 2: 24 VAC~ 50 / 60 Hz, 24 VDC≒
- 4: 100 - 240 VAC~ 50 / 60 Hz, 24 - 240 VDC≒

### ④ Output

- No mark: Time limit DPDT (2c),  
Time limit SPDT (1c) + Instantaneous SPDT (1c)
- D: Time limit DPDT (2c)
- E: Time limit SPDT (1c) + Instantaneous SPDT (1c)

## Product Components

- Product (+ bracket)
- Instruction manual

## Sold Separately

- 8-pin controller socket: PG-08, PS-08(N), PS-M8
- 11-pin controller socket: PG-11, PS-11(N)

## Dimensions

- Unit: mm, For the detailed drawings, follow the Autonics website.

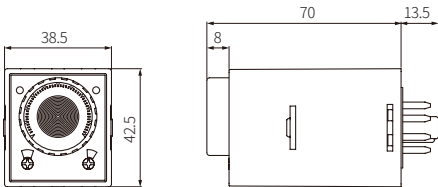

### Bracket

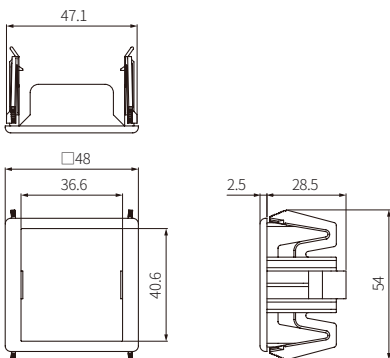

### Panel cut-out

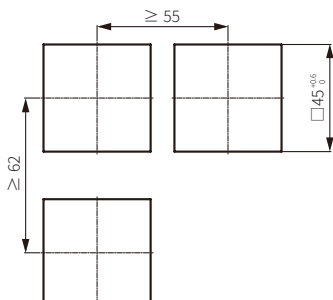

## Unit Descriptions

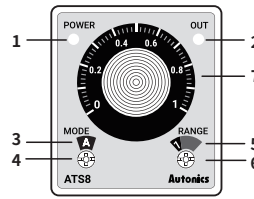

No.	Name
1	Power indicator
2	Time limit output indicator
3	Output operation mode display part
4	Output operation mode setting switch
5	Time range display part
6	Time range setting switch
7	Dial for the time setting

## Output Operation Mode

For the detailed timing chart for operation output mode, refer to the manual. The output operation mode differs depending on each model.

### ■ ATS8

A	Power ON Delay
A1	Power ON Delay 1 (One-shot output)
B	Power ON Delay 2
F	Flicker (OFF Start)
F1	Flicker 1 (ON Start)
I	Interval

### ■ ATS11

A	Signal ON Delay
F	Flicker (OFF Start)
F1	Flicker 1 (ON Start)
C	Signal OFF Delay
D	Signal ON/OFF Delay
I	Interval

## Time Range

Display part	Unit	Range	
		ATS□-□1□	ATS□-□3□
1S	SEC	0.1 to 1	0.3 to 3
10S		1 to 10	3 to 30
1M	MIN	0.1 to 1	0.3 to 3
10M		1 to 10	3 to 30
1H	HOUR	0.1 to 1	0.3 to 3
10H		1 to 10	3 to 30

## Connections

### ⚠ Caution

- Refer to the 'specifications' for checking the power supply and control output.
- The ATS11 model: Be sure to use terminal No. 2 as the common terminal to connect terminals No. 5, 6, and 7.  
Failure to follow this instruction may result in product malfunction.

### ■ ATS8

- Output operation mode: A, F

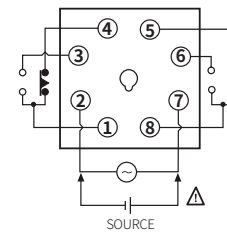

- Output operation mode: A1, B, F1, I

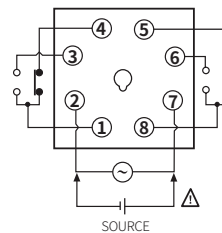

### ■ ATS11-□□D

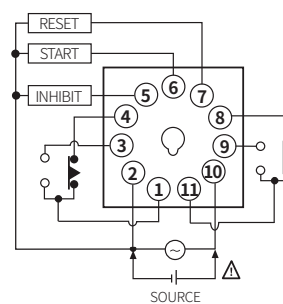

### ■ ATS11-□□E

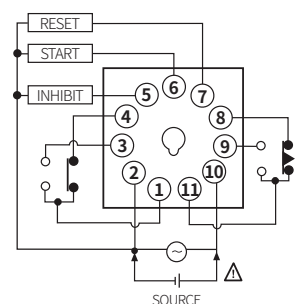

## Specifications

Model	ATS8-□□□□	ATS11-□□□D	ATS11-□□□E
<b>Function</b>	Multi Function Timer		
<b>Return time</b>	≤ 100 ms		
<b>Time operation</b>	Power ON Start	Signal ON Start	
<b>Input</b>	-	START, INHIBIT, RESET	
Min. signal width	-	≈ 50ms	
No-voltage input	-	Short-circuit impedance: ≤ 1 kΩ Short-circuit residual voltage: ≤ 0.5 VDC≐ Open-circuit impedance: ≥ 100 kΩ	
<b>Control output</b>	Relay		
Contact type	Time limit DPDT (2c), Instantaneous SPDT (1c) + Time limit SPDT (1c)	Time limit DPDT (2c)	Instantaneous SPDT (1c) + Time limit SPDT (1c)
Contact capacity	250 VAC~ 3 A, 30 VDC≐ 3 A resistive load	250 VAC~ 3 A, 24 VDC≐ 3 A resistive load	
<b>Error</b>	Repeat: ≤ ± 0.2% ± 10 ms SET: ≤ ± 5% ± 50 ms Voltage: ≤ ± 0.5% Temp.: ≤ ± 2%		
<b>Certification</b>	CE, ENEC, VDE, IEC, ENEC		
<b>Unit weight (packaged)</b>	≈ 70 g (≈ 95 g)		
<b>Power supply</b>	12 VDC≐	24 VAC~ 50 / 60 Hz, 24 VDC≐ ± 10%	100 - 240 VAC~ 50 / 60 Hz, 24 - 240 VDC≐
<b>Permissible voltage range</b>	90 to 110 % of rated voltage		
<b>Power consumption</b>	It depends on the plug type and output.		
ATS8-□□□□	DC: ≤ 1.5 W	AC: ≤ 4.5 VA DC: ≤ 2 W	AC: ≤ 4.2 VA DC: ≤ 2 W
ATS11-□□□D	DC: ≤ 1 W	AC: ≤ 4 VA DC: ≤ 1.5 W	AC: ≤ 3.5 VA DC: ≤ 2 W
ATS11-□□□E	DC: ≤ 1.5 W	AC: ≤ 4.5 VA DC: ≤ 2 W	AC: ≤ 4.2 VA DC: ≤ 2 W
<b>Insulation resistive</b>	≥ 100 MΩ (500 VDC≐ megger)		
<b>Dielectric strength</b>	Between the charging part and the case : 3,000 VAC~ at 50 / 60 Hz for 1 min		
<b>Noise immunity</b>	It depends on the power supply.		
ATS□-1□□□	± 500 V square-wave noise by noise simulator (pulse width 1 μs)		
ATS□-2□□□	± 2kV square-wave noise by noise simulator (pulse width 1 μs)		
ATS□-4□□□	± 2kV square-wave noise by noise simulator (pulse width 1 μs)		
<b>Vibration</b>	0.75 mm double amplitude at frequency of 10 to 55 Hz in each X, Y, Z direction for 1 hour		
<b>Vibration (malfunction)</b>	0.5 mm double amplitude at frequency of 10 to 55 Hz in each X, Y, Z direction for 10 min		
<b>Shock</b>	300 m/s <sup>2</sup> (≈ 30 G) in each X, Y, Z direction for 3 times		
<b>Shock (malfunction)</b>	100 m/s <sup>2</sup> (≈ 10 G) in each X, Y, Z direction for 3 times		
<b>Relay life cycle</b>	Mechanical: ≥ 10,000,000 operations Electrical: ≥ 100,000 operations (250 VAC~ 3 A resistive load)		
<b>Ambient temperature</b>	-10 to 55 °C, storage: -25 to 65 °C (no freezing or condensation)		
<b>Ambient humidity</b>	35 to 85 %RH, storage: 35 to 85 %RH (no freezing or condensation)		

## Output Operation Mode

### ■ ATS8

- t: setting time (t > t-a) / Rt: return time (Rt1 > Rt)

A

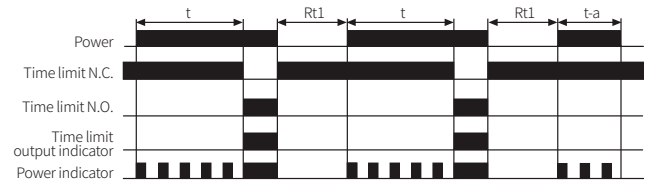

A1

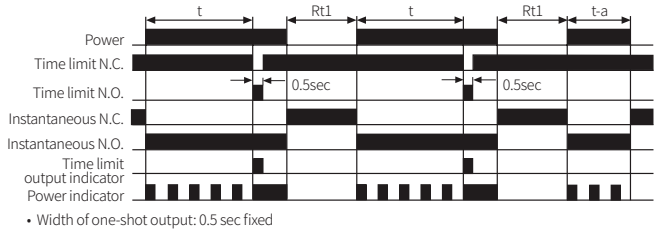

B

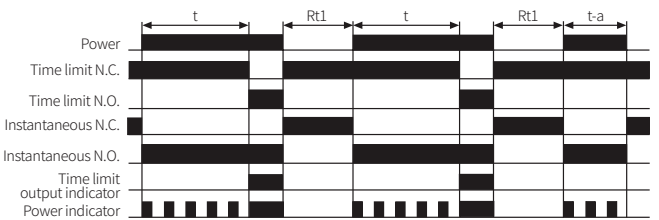

F

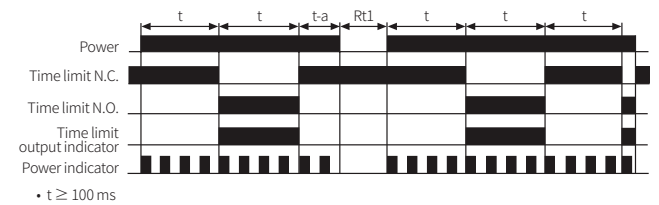

F1

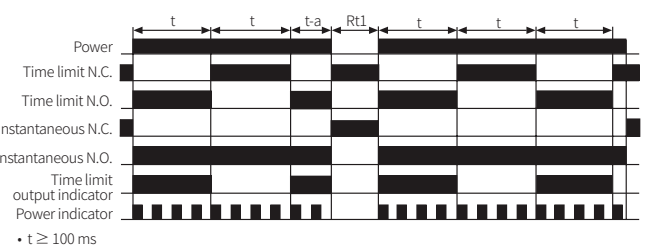

I

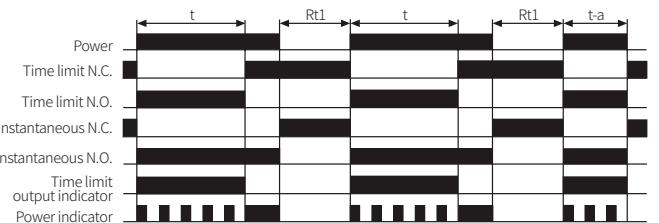

## ■ ATS11

If the INHIBIT terminal is short-circuited in the time limit operation, the time stops during the short-circuited time.

RESET: Turn OFF the power or short the RESET terminal.

- t: setting time ( $t > t-a$ ,  $t = t1 + t2$ )

**A**

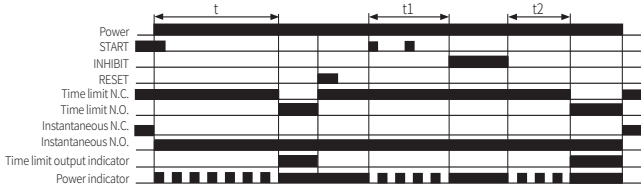

**F**

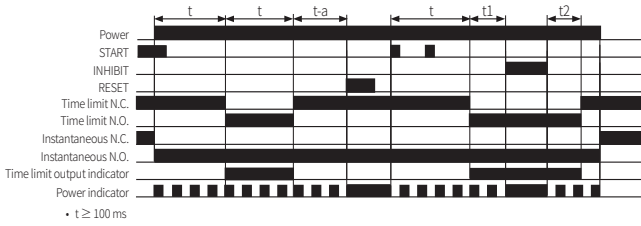

**F1**

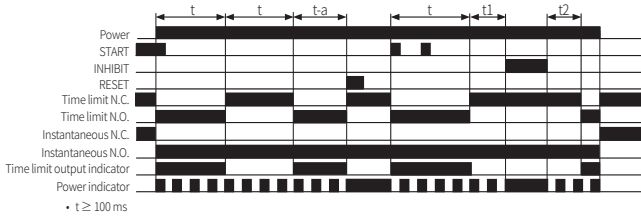

**C**

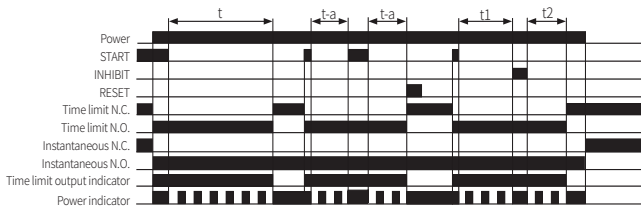

**D**

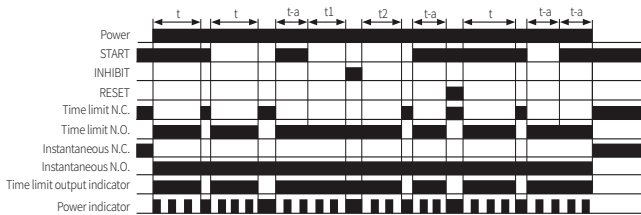

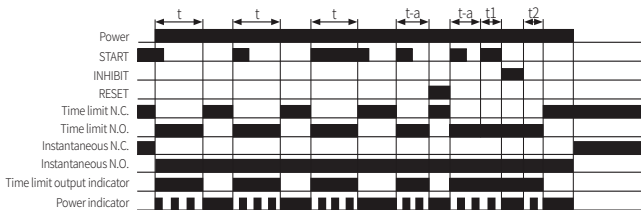

**I**





## Sold Separately: 8-pin Controller Socket

- For detailed information, refer to the 'PG Series, PS Series' manual.

Appearance	Pins	Rated Voltage	Rated current	Feature	Model
	8-pin	250 VAC~	7 A (resistance load)	Controller sockets	PG-08
	8-pin	250 VAC~	7 A (resistance load)	Controller sockets (DIN Rail / Panel)	PS-08(N)
	8-pin	250 VAC~	7 A (resistance load)	Controller sockets (only for ATS series)	PS-M8

## Sold Separately: 11-pin Controller Socket

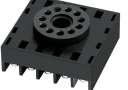
- For detailed information, refer to the 'PG Series, PS Series' manual.

Appearance	Pins	Rated Voltage	Rated current	Feature	Model
	11-pin	250 VAC~	7 A (resistance load)	Controller socket	PG-11
	11-pin	250 VAC~	7 A (resistance load)	Controller socket (DIN Rail / Panel)	PS-11(N)