

3-Phase Slim Power Controllers



SPR3 Series PRODUCT MANUAL

For your safety, read and follow the considerations written in the instruction manual, other manuals and Autonics website.

The specifications, dimensions, etc. are subject to change without notice for product improvement. Some models may be discontinued without notice.

Features

- Slim and elegant design
- LED display allows real-time monitoring of control input, load voltage, load current, load power, load resistance, and heat-sink temperature
- Stable control with feedback control (constant current, constant voltage, constant power)
- Communication output models available: RS485 (Modbus RTU)
- Parameter configuration via PCs (RS485) : Free device management software (DAQMaster)
- Various alarm functions (alarm output) : overcurrent, overvoltage, heater disconnection, fuse break, heat-sink overheat, diode (SCR) error
- Easy installation with mounting brackets
- Easy fuse replacement and maintenance
- Inter phase insulating barrier included
- High performance SCR (IXYS) diode

Safety Considerations

- Observe all 'Safety Considerations' for safe and proper operation to avoid hazards.
- ⚠ symbol indicates caution due to special circumstances in which hazards may occur.

⚠ Warning Failure to follow instructions may result in serious injury or death.

- 01. Fail-safe device must be installed when using the unit with machinery that may cause serious injury or substantial economic loss.** (e.g. nuclear power control, medical equipment, ships, vehicles, railways, aircraft, combustion apparatus, safety equipment, crime / disaster prevention devices, etc.)
Failure to follow this instruction may result in personal injury, economic loss or fire.
- 02. Do not use the unit in the place where flammable / explosive / corrosive gas, high humidity, direct sunlight, radiant heat, vibration, impact or salinity may be present.**
Failure to follow this instruction may result in explosion or fire.
- 03. Install on the device panel, and ground to the bolt for grounding separately.**
Failure to follow this instruction may result in fire or electric shock.
- 04. Do not connect, repair, or inspect the unit while connected to a power source.**
Failure to follow this instruction may result in fire or electric shock.
- 05. Check 'Connections' before wiring.**
Failure to follow this instruction may result in fire.
- 06. Do not disassemble or modify the unit.**
Failure to follow this instruction may result in fire or electric shock.

⚠ Caution Failure to follow instructions may result in injury or product damage.

- 01. Use the unit within the rated specifications.**
Failure to follow this instruction may result in fire or product damage.
- 02. Use a dry cloth to clean the unit, and do not use water or organic solvent.**
Failure to follow this instruction may result in fire or electric shock.
- 03. Keep the product away from metal chip, dust, and wire residue which flow into the unit.**
Failure to follow this instruction may result in fire or product damage.
- 04. Since leakage current still flows right after turning off the power or in the output OFF status, do not touch the load terminal.**
Failure to follow this instruction may result in electric shock.

Cautions during Use

- Follow instructions in 'Cautions during Use'.
Otherwise, it may cause unexpected accidents.
- Use the product, after 3 sec of supplying power.
- Before use, set the mode and function according to the specification. Especially, be cautious that the product does not operate when output control adjuster (OUT ADJ) is set to 0 %. Since changing the mode / parameter during operation may result in malfunction, set the mode and function after disconnecting load output.
- Re-supply the power to the unit after the unit is discharged completely. Failure to follow this instruction may result in malfunction.
- To ensure the reliability of the product, install the product on the panel or metal surface vertically to the ground.
- Install the unit in the well ventilated place.
- While supplying power to the load or right after turning off the power of the load, do not touch the body and heat sink. Failure to follow this instruction may result in a burn due to the high temperature.
- Install a power switch or circuit breaker in the easily accessible place for supplying or disconnecting the power.
- Do not wire to terminals which are not used.
- Use twisted pair wire for communication line.
- Since inter element can be damaged when using with coil load, inductive load, etc., the inrush current must be under the rated load current.
- Do not use near the equipment which generates strong magnetic force or high frequency noise.
- This unit may be used in the following environments.
 - Indoors (in the environment condition rated in 'Specifications')
 - Altitude max. 2,000 m
 - Pollution degree 2
 - Installation category III

Ordering Information

This is only for reference, the actual product does not support all combinations. For selecting the specified model, follow the Autonics website.

SPR 3 - ① ② ③ ④ ⑤

① Rated load voltage

- 1: 110 VAC~
- 2: 220 VAC~
- 3: 380 VAC~
- 4: 440 VAC~

② Rated load current

Number: Rated load current (unit: A)

③ Option output

- N: Alarm output
- T: Alarm output + RS485 comm. output

④ Feedback control

- N: Normal control
- F: Normal, feedback control (constant current / constant voltage / constant power)

⑤ Fuse

- N: None
- F: Supports fuse

Product Components

- Product
- Instruction manual
- 11-pin connector × 1
- Insulating barrier × 4

Manual

For proper use of the product, refer to the manuals and be sure to follow the safety considerations in the manuals. Download the manuals from the Autonics website.

Software

Download the installation file and the manuals from the Autonics website.

■ DAQMaster

It is the comprehensive device management program for Autonics' products, providing parameter setting, monitoring and data management.

Dimensions

• Unit: mm, For the detailed drawings, follow the Autonics website.

■ Rated load current 25 / 35 / 50 A

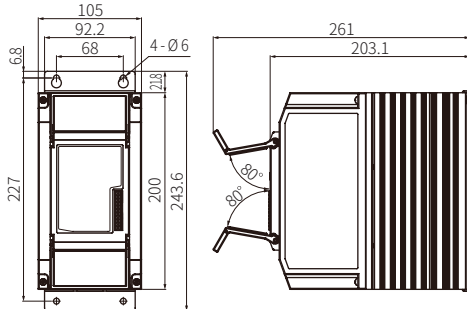

■ Rated load current 70 A

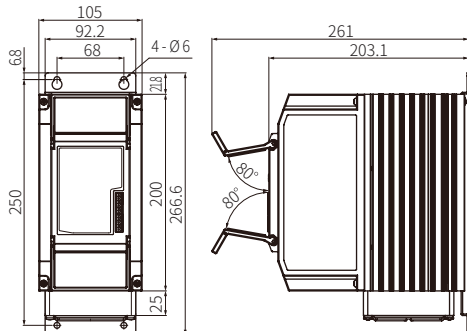

■ Rated load current 100 / 150 A

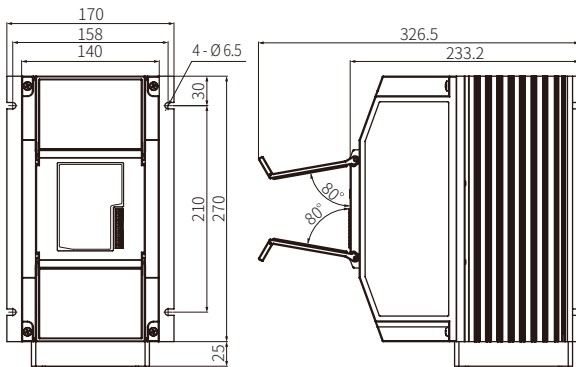

Insulating Barrier

It is recommended to use the included interphase barriers for insulation between phases and reduce influence from conductive material.

- Unit: mm, For the detailed drawings, follow the Autonics website.

• With the insulating barrier

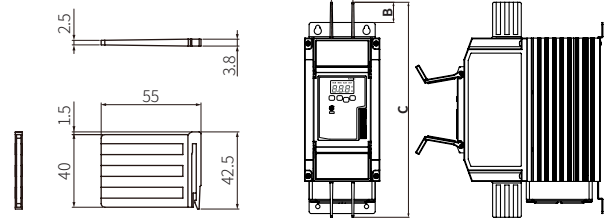

Rated load current	A	B	C
25 / 35 / 50 A	30	28.2	300
70 A	30	28.2	300
100 / 150 A	40.5	50	370

Cautions during Installation

⚠ High Temperature Caution

While supplying power to the load or right after turning off the power of the load, do not touch the body and heatsink. Failure to follow this instruction may result in a burn due to the high temperature.

■ Mount space

- Unit: mm
- When installing multiple power controllers, keep space between power controllers for heat radiation. Horizontal: ≥ 50 mm, vertical: ≥ 100 mm

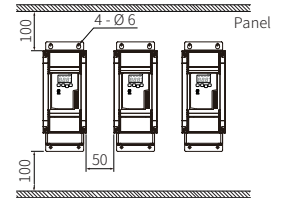

Unit Descriptions

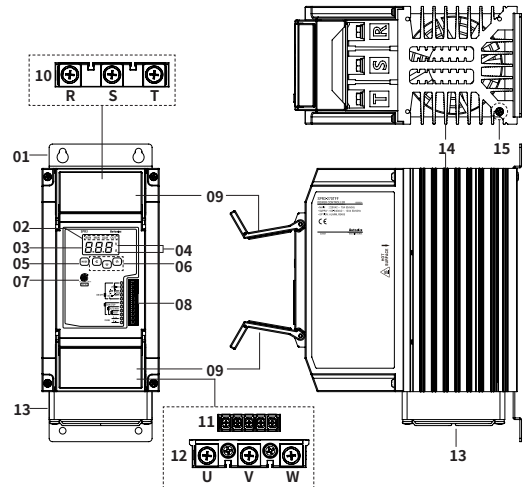

01. Bracket [except rated load current 100 / 150 A model]

02. Indicator

Indicator	Function
RUN	Operation indicator (green) Turns on in the RUN mode.
MAN	Manual control indicator (green) Turns on when adjusting load output in the manual control mode.
ALM	Alarm indicator (red) Flashes in alarming status.
OUT	Output indicator (red) Turns on when load control outputs.

03. Display part

RUN mode: Displays depending the front display setting
Setting mode: Displays parameter and setting value

04. Unit indicator (V, A)

Dependent on the display setting.

Display setting	V	A
Resistance and input	OFF	OFF
Voltage	ON	OFF
Current	OFF	ON
Power	ON	ON

05. [MODE] key

Enters parameter group, returns to RUN mode, moves parameters, and saves the setting value.

06. [◀], [▼], [▲] key

Enters SV setting mode and move digits.

07. Output control adjuster (OUT ADJ)
Adjusts output from 0 to 100% in manual control.

08. Control input / comm. output terminal (11-pin connector terminal)

09. Terminal protection cover

10. R, S, T load input terminal

11. Alarm output / power input terminal

12. U, V, W load output terminal

13. Cooling fan
[Rated load current 70 / 100 / 150 A model]

14. Heatsink

Rated load current 100 / 150 A models have left / right mounting holes.

15. Bolt for grounding (M4)

Cautions during Wiring

■ Control input / comm. output terminal (11-pin connector)

- Unit: mm, Use penhole terminals of size specified below.

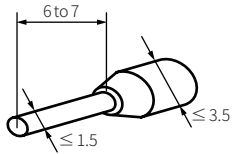

■ Alarm output / power input & U, V, W load output terminal

- Unit: mm, Use crimp terminals of size specified below.

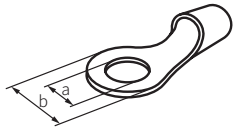

Rated load current	Spec.	Alarm output / power input	Load input / output
25 / 35 / 50 / 70 A	a	≥ 3.0	≥ 6.0
	b	≤ 6.0	≤ 16.0
100 / 150 A	a	≥ 3.0	≥ 8.0
	b	≤ 6.0	≤ 26.0

- Cable / screw / tightening torque spec. is different depending on the load current. Be sure to the below before connection.

Rated load current	Spec.	Alarm output / power input	Load input / output
25 / 35 / 50 / 70 A	Cable	AWG 18 to 14	AWG 13 to 4
	Screw	M3	M6
	Tightening torque	0.5 N m	5.5 to 6.0 N m
100 / 150 A	Cable	AWG 18 to 14	AWG 4 to 2 / 0
	Screw	M3	M8
	Tightening torque	0.5 N m	6.5 to 7.0 N m

Connections

- Terminal configuration by model may differ depending on the supported spec.

■ Control input / comm. output terminal (11-pin connector)

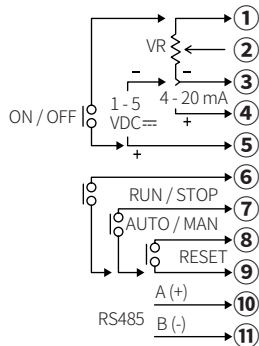

■ Load input / output terminal

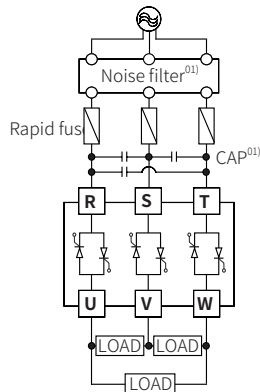

- 01) When connecting noise filter and capacitor, it is appropriate for EMC. [CAP]
 Rated load voltage 110 / 220 VAC~ : 1 μF / 250 VAC~
 Rated load voltage 380 / 440 VAC~ : 0.47 μF / 500 VAC~

■ Alarm output / power input terminal

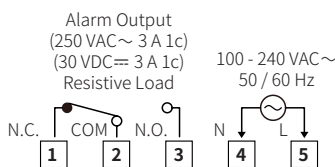

Specifications

Model	SPR3-1	SPR3-2	SPR3-3	SPR3-4
Control phase	3-Phase			
Rated load voltage	110 VAC~ 50 / 60 Hz	220 VAC~ 50 / 60 Hz	380 VAC~ 50 / 60 Hz	440 VAC~ 50 / 60 Hz
Rated load current	25 / 35 / 50 / 70 / 100 / 150 A			
Display method	3-digit 7segment LED			
Indicators	Operation / manual control indicator (green) Alarm / output / unit (V, A) indicator (red)			
Auto control input	Current ⁰¹⁾ : DC 4 - 20 mA, voltage: 1 - 5 VDC=, contact (non-voltage): ON / OFF, contact (voltage): 5 - 12 VDC=, communication: RS485			
Manual control input	External adjuster (10 kΩ), output control adjuster (OUT ADJ)			
Digital input (DI)	RUN / STOP selectable, AUTO / MAN selectable, RESET			
Alarm output	250 VAC~ 3 A, 30 VDC= 3 A, 1c resistance load			
RS485 comm. output	Modbus RTU method			
Cooling method	Rated load current 25 / 35 / 50 A: natural cooling Rated load current 70 / 100 / 150 A: forced air cooling (with cooling fan)			
Unit weight (packaged)	Rated load current 25 / 35 / 50 A: ≈ 4.1 kg (≈ 4.9 kg) Rated load current 70 A: ≈ 4.2 kg (≈ 5 kg) Rated load current 100 / 150 A: ≈ 8.7 kg (≈ 9.7 kg)			
Certification	CE UK			

01) Input impedance = 62 Ω

Control method	Phase control	Cycle control	ON/OFF control
Control mode	Normal, Constant current / voltage / power feedback	Fixed cycle	-
Applied load	Resistance load, inductive load	Resistance load	Resistance load, inductive load
Output range	0 to 98 %	0 to 100 %	0 / 100 %
Phase control output accuracy	<ul style="list-style-type: none"> Normal control: within ± 10 % F.S. of rated load voltage Constant current feedback control: within ± 3 % F.S. of rated load current Constant voltage feedback control: within ± 3 % F.S. of rated load voltage Constant power feedback control: within ± 3 % F.S. of rated load power 		

Power supply	100 - 240 VAC~ 50 / 60 Hz
Permissible voltage range	90 to 110 % of rated voltage
Min. load current	1 A
Power consumption	Rated load current 25 / 35 / 50 A: ≤ 14 VA Rated load current 70 A: ≤ 22 VA Rated load current 100 / 150 A: ≤ 32 VA
Insulation resistance	≥ 200 MΩ (500 VDC= megger)
Dielectric strength	Between the charging part and the case: 3,000 VAC~ 50 / 60 Hz for 1 min
Output leakage current	≤ 10 mA rms
Noise immunity	± 2 kV square wave noise (pulse width: 1 μs) by the noise simulator
Memory retention	≈ 10 years (when using non-volatile semiconductor memory type)
Vibration	0.75 mm double amplitude at frequency of 5 to 55 Hz in each X, Y, Z direction for 2 hours
Vibration (malfunction)	0.5 mm double amplitude at frequency of 5 to 55 Hz in each X, Y, Z direction for 10 min
Ambient temperature	-10 to 55 °C, storage: -20 to 80 °C (no freezing or condensation)
Ambient humidity	35 to 85 %RH, storage: 35 to 85 %RH (no freezing or condensation)

Communication Interface

■ RS485

Comm. protocol	Modbus RTU
Application standard	Compliance with EIA RS485
Max. connection	31-unit (address: 01 to 99)
Comm. synchronous method	Asynchronous
Comm. method	2-wire half duplex
Comm. distance	≤ 800 m
Comm. speed	2,400 / 4,800 / 9,600 / 19,200 / 38,400 bps
Comm. response time	5 to 99 ms (default: 20 ms)
Start bit	1-bit (fixed)
Data bit	8-bit (fixed)
Parity bit	None, Even, Odd
Stop bit	1-bit, 2-bit

Load Output Formula

Type	Input	Formula
Auto (AUTO)	Current	DC 4 - 20 mA
	Voltage	1 - 5 VDC=
	RS485 communication	
Manual (MAN)	Output control	Output control adjuster (OUT ADJ)
		External adjuster
		Output control (OUT ADJ) / external adjuster

Load output [%] = Control input [%] × output slope [%]
 Load output [%] = RS485 [%]
 Load output [%] = output control adjuster [%]
 Load output [%] = external adjuster [%]
 Load output [%] = output control adjuster [%] × External adjuster [%]

Alarm

- Supported alarms are different depending on the model.
- When several alarms occur at same time, the highest priority error is displayed based on priority.

Priority	Type	Display	Operation		Alarm release	Model
			Alarm	Output		
1	SCR error	5 C r	<ul style="list-style-type: none"> Error display flashes. Alarm indicator (ALM) flashes. Alarm output turns ON 	Output stops. (SCR OFF)	<ul style="list-style-type: none"> Re-supply power. RESET input Switch to stop (STOP) mode. 	Feedback control
2	Over current	o - C				Feedback control
4	Heatsink over heat	t E n		Normal operation / Output stops. (SCR OFF)	Automatically cleared when returning within the setting range	Normal / Feedback control
5	Over voltage	o - u				
7	Load unbalance	UL		Output stops. (SCR OFF)	Normal operation	Feedback control
3	Fuse break	F U S		Output stops. (SCR OFF)		
8	Frequency error	F r 9	Normal operation	Feedback control		
6	Heater break	H - b				

SCR error alarm

Even though output is 0%, if the current of 10% or more of the rated load current flows for over 3 sec continuously, SCR error alarm occurs.

Over current alarm

This function protects the load from over current. If the current flows over the P2-7 over current alarm value and P2-8 over current alarm delay time, over current alarm occurs.

Heatsink over heat alarm

When the temperature of a heatsink is over 85 °C, heatsink over heat alarm occurs.

Over voltage alarm

This function protects the load from over voltage. If the current flows over the P2-9 over voltage alarm value and P2-10 over voltage alarm delay time, over voltage alarm occurs.

Load unbalance alarm

If the current of U, V, W is [load unbalance value ≥ P2-13 load unbalance alarm value], the alarm occurs.

When the alarm occurs, the load output operates as according to the set of P2-14 output when load unbalance alarm occurs.

→ ON: normal operation, OFF: output stops (SCR OFF)

Load unbalance value (A) = $I_{max} - I_{min}$

(I_{max} : maximum phase load current value, I_{min} : minimum phase load current value)

E.g.) R phase: 7 A, S phase: 2 A, T phase: 3 A, P2-13 load unbalance alarm value: 2 A

Load unbalance value = 7 - 2 = 5 A

Load unbalance value > P2-13 load unbalance alarm value and the alarm occurs.

Fuse break alarm

When breaking fuse, not supplying load power, breaking load (single load), fuse brake alarm occurs. In the case of normal control model, real-time fuse break alarm is not available during output, and fuse break alarm operates at 0% output such as RESET.

Heater break alarm

Comparing the full load resistance value and the current load resistance value, if the current load resistivity is maintained under the P2-12 heater break alarm value for over 3 sec continuously, heater break alarm occurs. This alarm operates when control output is over 10% and load current is over 10% of the rated current. Output does not stop and operates normally.

$$\text{Current load resistance (\%)} = \frac{\text{Full load resistance value} \times 100}{\text{Current load resistance value}}$$

Frequency error alarm

When the load power frequency is out of the specification, frequency error alarm occurs.

Replacement of Fuse

Case removal

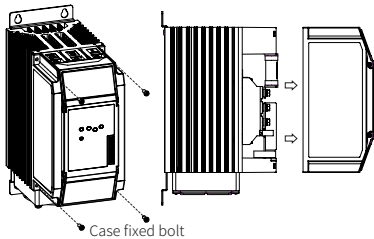

Replacement of fuse

- Fuse none model is not equipped with a rapid fuse inside. Install the suitable fuse for rated load current of the model separately.
- The performance of the product is guaranteed only when using the fuse provided by us. For replacing the fuse, use the recommended fuse.

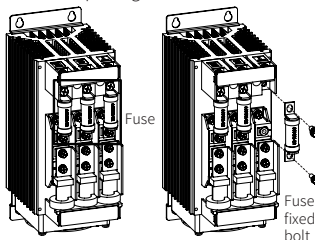

Rated load current	Rec. fuse	Manufacturer
25 A	50FE	BUSSMANN
35 A	63ET	
50 A	80ET	
70 A	100FE	
100 A	660GH-160	HINODE
150 A	660GH-200	

Bolt specification

Rated load current	Case fixed bolt	Fuse fixed bolt
25 / 35 / 50 / 70 A	M3	M6
100 A	M4	Top: M8 Bottom: M6
150 A	M4	M8

Derating Curve

Rated load current 25 A

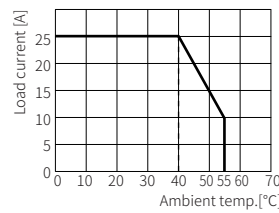

Rated load current 35 A

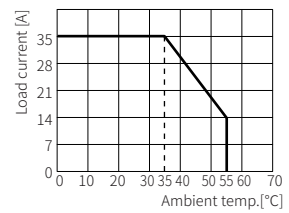

Rated load current 50 A

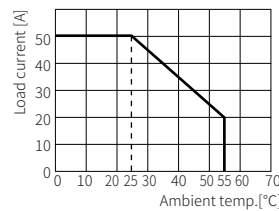

Rated load current 70 A

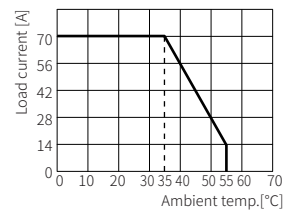

Rated load current 100 A

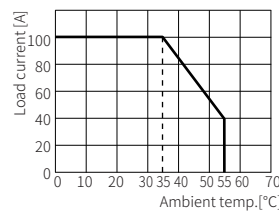

Rated load current 150 A

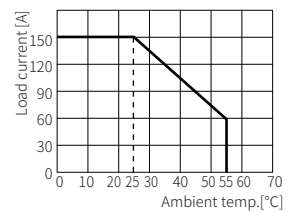

Mode Setting

[MODE]	→	Monitoring group	[MODE] 3 sec	→	
[MODE] 2 sec	→	Parameter 1 group	[MODE] 3 sec	→	
[MODE] 4 sec	→	Parameter 2 group	[MODE] 3 sec	→	
RUN	← [▲+▲+▼] 5 sec	→	Parameter reset	[MODE]	→ RUN
	6 - 9 terminal external contact	→	RUN / STOP	Auto	→
	7 - 9 terminal external contact	→	Auto / Manual control	Auto	→
	[▲+▼] 2 sec or 8 - 9 terminal	→	Reset ⁰¹⁾	Auto	→

01) In the event of system anomalies and alarms, RESET input restarts the power controller. (parameters are not reset.)

Parameter Setting

- Some parameters are activated / deactivated depending on the model or setting of other parameters. Refer to the description of each parameter.
- If any key is not entered for 30 sec in each parameter, it returns to RUN mode.
- [MODE] key: Saves current setting value and moves to the next parameter.
- [◀] key: Changes setting digits.
- [▲], [▼] key: Changes setting values.

Monitoring group

Parameter	Display	Display range
M1-1 Monitoring value	t n	0 to 100 %
M1-2 U-V line load voltage value	U - u	[Feedback control model] 0 to rated voltage range, V
M1-3 V-W line load voltage value	u - u	
M1-4 W-U line load voltage value	u - U	
M1-5 U-phase load current value	U - A	[Feedback control model] 0 to rated current range, A
M1-6 V-phase load current value	u - A	
M1-7 W-phase load current value	u - A	
M1-8 Load power value	t - u	[Feedback control model] 0 to rated Power range, kW
M1-9 Resistance value percentage	t - r	[Feedback control model] 0 to 100 % • Displays the present resistance as percentage compared to the set resistance of full load auto recognition.
M1-10 Heatsink temp.	t n P	0 to 100 °C
M1-11 Power supply frequency	F r 9	50, 60 Hz

Parameter 1 group

Parameter	Display	Default	Setting range
P1-1 SOFT START time	S - t	3	[Normal and Cycle control model] 0 to 100 sec
P1-2 SOFT UP time	U - t	3	[Feedback control model] 0 (reach target output value quickly) to 100 (reach target output value slowly)
P1-3 SOFT DOWN time	d - t	3	
P1-4 Output low-limit value	L - L	0	0 ≤ L-L ≤ H-L ≤ 100 %
P1-5 Output high-limit value	H - L	100	
P1-6 Output slope ⁰¹⁾	S L P	100	0 to 100 % • In case of auto control (AUTO), set the output slope limit proportional to control input for limit load power.

Parameter 2 group

Parameter	Display	Default	Setting range
P2-1 Control input ⁰¹⁾	i n t	420	420: DC 4 - 20 mA 1-5: 1 - 5VDC 512: 5 - 12 VDC (contact - voltage) ONF: ON / OFF (contact - non-voltage) COM: RS485 communication
P2-2 Control method	C - m	PR	*[Feedback control model] Set Control method PA Normal V-F* Phase control C-F* Constant voltage feedback W-F* Constant current feedback F-C Cycle control ONF ON / OFF control
P2-3 Manual control (MAN) input ⁰¹⁾	m a n	1 - r	L_R: Output control adjuster E_R: External adjuster E_I: Output control / external adjuster
P2-4 Input correction ⁰¹⁾	i n b	00	-99 to 99 %
P2-5 Input slope correction ⁰¹⁾	S P n	00	
P2-6 Front display	d i s	i n	*[Feedback control model] IN: Resistance and input U-V*: U-V line load voltage V-W*: V-W line load voltage W-U*: W-U line load voltage U-A*: U-phase load current V-A*: V-phase load current W-A*: W-phase load current L-W*: Load power
P2-7 Over current alarm value	o c u	120	[Feedback control model] 0 to 120 %
P2-8 Over current alarm delay time	o c t	5	[Feedback control model] 0 to 100 sec
P2-9 Over voltage alarm value	o v u	120	[Feedback control model] 0 to 120 %
P2-10 Over voltage alarm delay time	o v t	5	[Feedback control model] 0 to 100 sec
P2-11 Load resistance value auto recognition	F - L	o F F	[Feedback control model] OFF, ON • It executes 100 % control output for 3 sec and the load resistance value recognized automatically as the initial set when the function is ON.
P2-12 Heater break alarm value	H b u	10	[Feedback control model] 10 to 100 %, OFF
P2-13 Load unbalance alarm value	u l	0	[Feedback control model] 0: Not used, 1 to 50 A
P2-14 Output when load unbalance alarm occurs	u l o	o n	[Feedback control model] ON: Normal operation OFF: Output stops (SCR OFF)
P2-15 Frequency error alarm disable / enable	F r e	o n	OFF: Disable ON: Enable
P2-16 Comm. address	A d r	0 1	[RS485 communication output model] 01 to 99
P2-17 Comm. speed	b P S	96	[RS485 communication output model] 24, 48, 96, 192, 384 bps (× 100)
P2-18 Comm. parity bit	P r b	n o n	[RS485 communication output model] NON, EVE, ODD
P2-19 Comm. stop bit	S t P	2	[RS485 communication output model] 1, 2 bit
P2-20 Comm. response time	r s t	20	[RS485 communication output model] 5 to 99 ms
P2-21 Comm. write	C r i	E n A	[RS485 communication output model] ENA: Enable, DSA: Disable
P2-22 Lock	L o c	o F F	OFF LC1: Locks parameter 1 group LC2: Locks parameter 2 group
P2-23 Parameter reset	i n i	n o	NO, YES

01) Set the below parameters available depends on the control input.

Type	Control input	Display	Input correction	Input slope correction	Output slope	Monitoring value	
Auto control (AUTO)	Current	DC 4 - 20 mA	420	○	○	The last control input value 0 to 100 %	
	Voltage	1 - 5 VDC	1-5	○	○		
	Contact-voltage	5 - 12 VDC	512	×	×		○
	Contact - non-voltage	ON / OFF	ONF	×	×		○
	RS485 communication		COM	×	×		×
Manual control (MAN)	Output control	Output control adjuster (OUT ADJ)	L_R				
		External adjuster	E_R	×	×	×	
		Output control (OUT ADJ) / external adjuster	E_I				

Control Method

Phase control

Phase control method is to control output by dividing AC phase by control input signal.

• Normal = Phase equal division method by control input

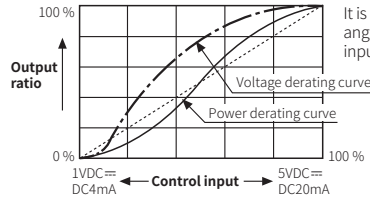

It is general output method to divide control angle proportionally according to control input signal and to output it.

• Constant voltage feedback control mode

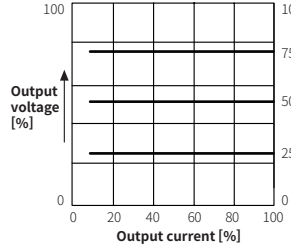

It outputs a constant voltage proportional to the control input so that the output voltage does not fluctuate against fluctuations in power voltage and load resistance fluctuations of loads (iron, chromium, nichrome, etc.) with a small electrical resistance temperature coefficient.

• Constant current feedback control mode

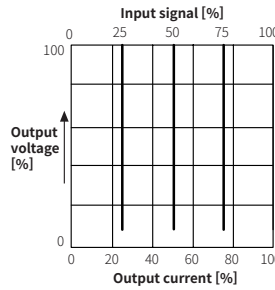

It outputs a constant current proportional to the control input so that the output current does not fluctuate against fluctuations in power voltage and load resistance fluctuations of loads (platinum, molybdenum, tungsten, etc.) in which the temperature coefficient of electrical resistance varies significantly from 6 to 12 times the normal temperature.

• Constant power feedback control mode

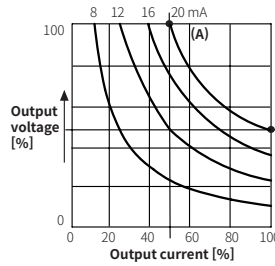

It is proper control method for a heater which resistance value variation by silicon carbide (SiC) heating is big. It outputs constant power which is proportion to control input even though load variation and power supply variation.

- (A): [output voltage 100 % × output current 50 %]
- (B): [output voltage 50 % × output current 100 %]
- Output characteristics is proper 50 % of the curve which connects the point (A) and the point (B). The current output capacity of this unit should be over two times of load capacity.

Cycle control, zero cross turn-on

Compared to the phase control method, the load control linearity is better.

Since it is always ON or OFF at the zero point of AC, no noise is generated during ON / OFF, so it is a suitable control method for an environment where noise is not affected or an electric furnace with a large heat capacity.

• Fixed cycle control mode

During fixed cycle (60 cycles) of load power, it repeats ON / OFF cycle as constant ratio according to control input signal and controls the power supplies on the load.

When controlled by 40 % of the control output signal

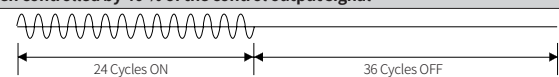

When controlled by 90 % of the control output signal

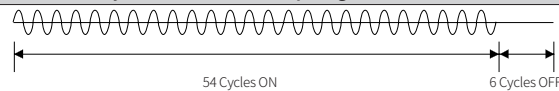

• Variable cycle control mode

By optimizing the number of cycles of the load power, it controls the power applied to the load by operating ON / OFF at a ratio proportional to the control input signal.

When controlled by 30 % of the control output signal

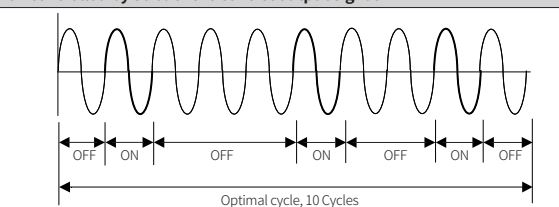

ON / OFF control, zero cross turn-on

This is control method that output is 100 % at control input ON, and 0 % at control input OFF. It is the same function as SSR (Solid State Relay). It always turns ON or OFF at zero point of AC.

- When using ON / OFF control method, output control, SOFT START, SOFT UP / DOWN, input correction, and input slope correction functions are not settable.

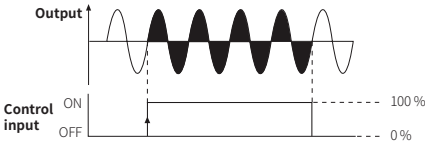

Function

Output high / low-limit value

This function is to limit output range to protect load.

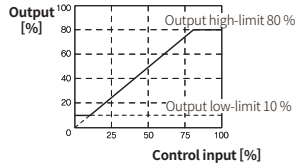

SOFT START

- This function protects the load in cases that the set temperature is high, such as controlling the load (platinum, molybdenum, tungsten, infrared lamp, etc.) in which inrush current flows when power is supplied, or showing large width of temperature rise during initial operation.
- SOFT START set time (T) is the required time that output reaches to 100 %.
- It is not available at ON / OFF control method.

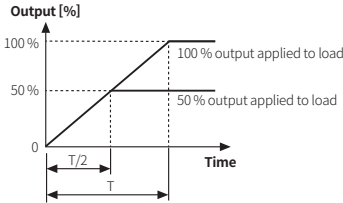

- T: SOFT START set time. Time to get the output which is applied into the load is 100 %.
- T/2: Time to get the output which is applied into the load is 50 %.

SOFT UP / DOWN

Unlike SOFT START which operates only once at supplying power, this function protects load from the inrush current in the RUN mode. When reached to the target output value, operation stops.

- It is not available at ON / OFF control method.

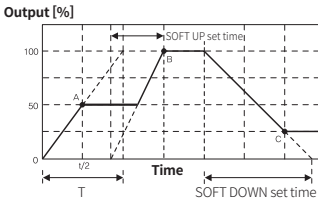

- T: SOFT START set time
- A: SOFT START function finished
- B: SOFT UP function finished
- C: SOFT DOWN function finished

Input correction

It compensates the offset between actual input value and measured input value.

E.g.) When input monitoring value is 5 % at 4 mA in DC4 - 20 mA control input, setting INB = -5 calibrates the input monitoring value to 0 %.

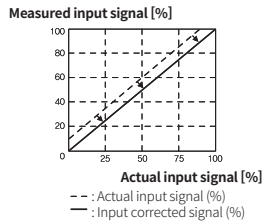

Input slope correction

It compensates the gain of the measured 100 % input for actual 100 % input value.

Calibrated monitoring value =
Monitoring value +
 $\frac{\text{Monitoring value}}{100 - \text{input slope correction value}} \times \text{Input slope correction value}$

E.g.) When the input monitoring value is 99 % at 20 mA in DC4 - 20 mA control input, setting input slope correction value = 1 calibrates the input monitoring value to 100 %.

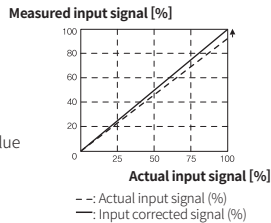

Segment Table

The segments displayed on the product indicate the following meanings. It may differ depending on the product.

7 segment	11 segment	12 segment	16 segment
0	0	0	0
1	1	1	1
2	2	2	2
3	3	3	3
4	4	4	4
5	5	5	5
6	6	6	6
7	7	7	7
8	8	8	8
9	9	9	9
A	A	A	A
b	b	b	b
c	c	c	c
d	d	d	d
E	E	E	E
F	F	F	F
G	G	G	G
H	H	H	H
I	I	I	I
J	J	J	J
K	K	K	K
L	L	L	L
M	M	M	M
N	N	N	N
O	O	O	O
P	P	P	P
Q	Q	Q	Q
R	R	R	R
S	S	S	S
T	T	T	T
U	U	U	U
V	V	V	V
W	W	W	W
X	X	X	X
Y	Y	Y	Y
Z	Z	Z	Z